

GU 10 - 11 GIUNTO MULTIPRESA

1	2	3	4	5	GU 11
Corpo Body Corps Körper	Otturatore Valve Clapet Ventil	Molle Springs Ressorts Feder	Guarnizioni Seals Joint d'étanchéité Dichtung	Sfere Balls Billes Kugel	Innesti Plugs Embouts Stecker
Ottone UNI EN 12164 CW614N Nichelato Brass UNI EN 12164 CW614N Nickel plated Laiton UNI EN 12164 CW614N Nickelé Ms Vernickelt UNI EN 12164 CW614N	Ottone UNI EN 12164 CW614N Nichelato Brass UNI EN 12164 CW614N Nickel plated Laiton UNI EN 12164 CW614N Nickelé Ms Vernickelt UNI EN 12164 CW614N	Acciaio Inox AISI 302 Stainless Steel AISI 302 Acier Inox AISI 302 Edelstahl AISI 302	NBR NBR NBR NBR	Acciaio Inox AISI 420 Stainless Steel AISI 420 Acier Inox AISI 420 Edelstahl AISI 420	Acciaio Nichelato Nickel plated steel Acier Nickelé Stahl Vernickelt

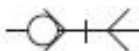
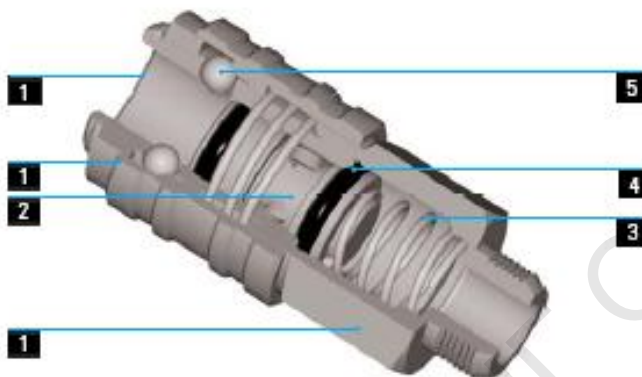

Intercambiabilità con i profili
Suitable with following plugs profiles
Interchangeable avec les suivants profils
Austauschbar mit folgenden Profilen

Portata a 6 bar
Flow rate at 6 bar
Débit à 6 bar
Durchfluß (6 bar)



Profilo Europeo
European Profile
Profil européen
Europäisches Profil

1600 NI/min

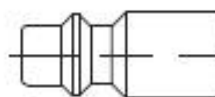

Profilo ISO 6150 B
ISO 6150 B Profile
Profil ISO 6150 B
ISO 6150 B Profil

1280 NI/min

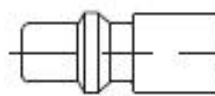

Profilo Svedese
Standard Swedish Profile
Profil Standard Suédois
Standard schwedisches Profil

1280 NI/min

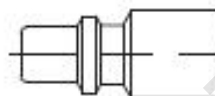

Profilo Italiano
Standard Italian Profile
Profil Standard Italien
Standard Italienisches Profil

1080 NI/min

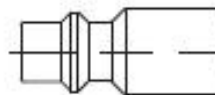

Profilo MIL C4109
MIL C4109 Profile
Profil MIL C4109
MIL C4109 Profil

1310 NI/min

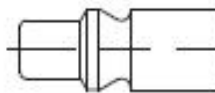

Profilo ARD 210
ARD 210 Profile
Profil ARD 210
ARD 210 Profil

1160 NI/min

Scala 1:1 - Scale 1:1 - Echelle 1:1 - Maßstab 1:1

GIUNTO MULTIPRESA

MULTI PROFILE QUICK COUPLER

COUPLEUR MULTIPROFIL

MULTIPROFILKUPPLUNG

Pressione di esercizio: 0 ÷ 15 bar
Temperatura di esercizio: -20°C ÷ 70°C

Working pressure: 0 ÷ 15 bar
Working temperature: -20°C ÷ 70°C

Pression de service: 0 ÷ 15 bar
Températures de service: -20°C ÷ 70°C

Druckbereich: 0 ÷ 15 bar
Temperaturbereich: -20°C ÷ 70°C

GU 10-11

Giunto con filetto maschio

Male coupling

Coupleur mâle

Einschraubkupplung

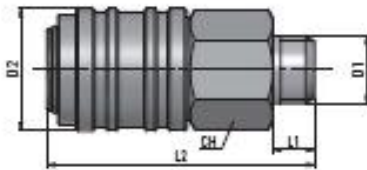

Tipo	D ₁	D ₂	L ₁	L ₂	CH	g
11 00 14	G1/4	23,5	10	52	20	98
11 00 38	G3/8	23,5	11	52	20	92
11 00 12	G1/2	23,5	11	52	24	118

GU 10-12

Giunto con filetto femmina

Female coupling

Coupleur femelle

Aufschraubkupplung

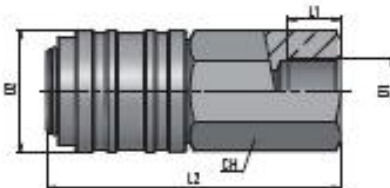

Tipo	D ₁	D ₂	L ₁	L ₂	CH	g
12 00 14	G1/4	23,5	10	57	20	109
12 00 38	G3/8	23,5	11	58	20	104
12 00 12	G1/2	23,5	11	60	24	134

GU 10-13

Giunto con portagomma

Coupling with hose connection

Coupleur avec douille cannelée

Kupplung mit Schlauchdüse

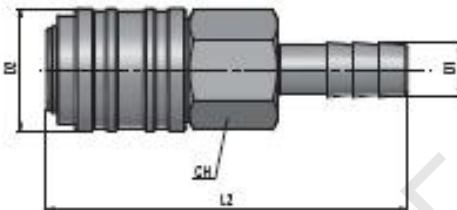

Tipo	Ø Tubo	D ₁	D ₂	L ₁	CH	g
13 06 00	6	7,5	23,5	70	20	92
13 09 00	9	10,5	23,5	70	20	93
13 13 00	13	14,5	23,5	70	20	107

GU 11-20

Innesto Italia con filetto maschio

Male plug, Italian profile

Embout mâle, profil italien

Einschraubverschlußnippel, italienisches Profil

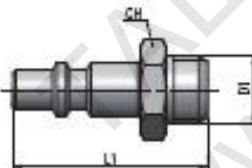

Tipo	D ₁	L ₁	CH	g
20 00 14	G1/4	37,5	14	17
20 00 38	G3/8	40	19	28
20 00 12	G1/2	40,5	24	43

GU 11-21

Innesto Italia con filetto femmina

Female plug, Italian profile

Embout femelle, profil italien

Aufschraubverschlußnippel, italienisches Profil

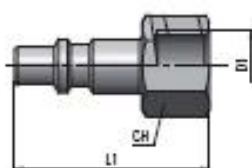

Tipo	D ₁	L ₁	CH	g
21 00 14	G1/4	39	17	23
21 00 38	G3/8	41	19	26